

LED Multi-Pendant

MP14970
INSTALLATION SHEET

START FROM HERE

- Make sure power is completely off at the fuse box.
- Have your fixture installed by a qualified licensed electrician
- Prepare everything in a clear area.
- Wear gloves at all times during this installation.
- Read instructions carefully before you start assembly.
- Keep this instruction sheet for future reference.

Technical Support: 1-855-855-8926

Please Note:

- For dimming, a TRIAC or an ELV type of dimmer is required.

- 1.** Remove the fixture from its original packaging. Next, remove the mounting plate (1c) from the canopy (2a) by un-threading the decorative nuts (2b). Attach the mounting plate (1c) to the junction box (1a) using two set screws (1d). For additional support, add wood screws (1e) to the plastic anchors (1f) in the ceiling.
- 2.** Before you mount the canopy to the mounting plate select the desired length you wish the pendant to hang. To set the fixture hanging height, simply push in the sleeve (2c) at the canopy where the wire comes out from. Push the wire up to shorten, or pull the wire down to lengthen. Release the sleeve (2c) and the wire will be held tightly in place.
- 3.** You are now ready to mount the canopy. First connect all wires correctly black to black "L", white to white "N" and the ground wire with provided marrettes (1b) from the hardware package. Align the threaded studs (1g) with the holes on the surface of the canopy (2a). Next, push the canopy (2a) up towards the mounting plate (1c) and thread on the decorative nuts (2b) on to the threaded studs (1g). This will secure the canopy to the mounting plate.
- 4.** You have now completed the installation of your fixture, enjoy.

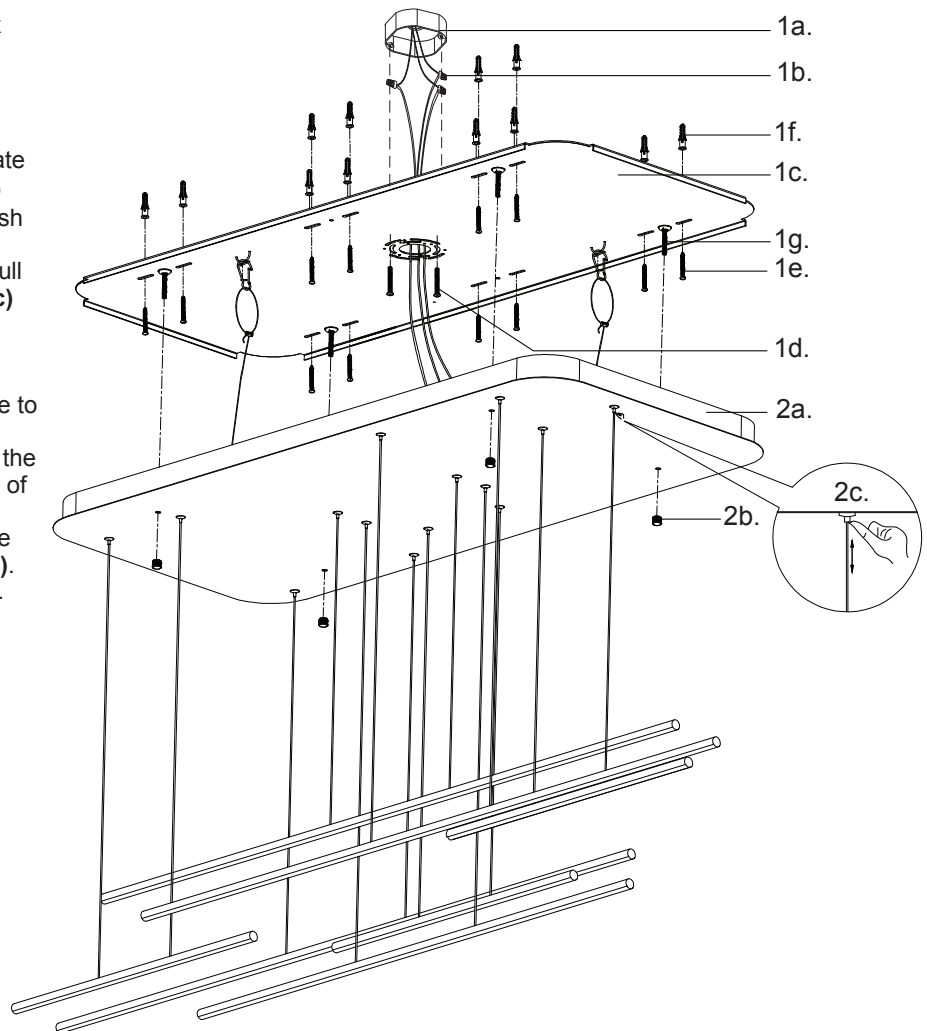

KUZCO

19054 28th Avenue Surrey, BC Canada V3Z 6M3
T: 604 538 7162 TF: 1-855 85 KUZCO F: 604 538 7196
W: kuzcolighting.com
20191202