

Ceiling LED Pendant

PD82548
INSTALLATION SHEET

START FROM HERE

- Make sure **POWER** is **COMPLETELY OFF** at the fuse box
- Have your fixture installed by a qualified licensed electrician
- Prepare everything in a clear area
- Wear gloves at all time during this installation
- Read instructions carefully before you start assembly
- Keep this installation sheet for future reference

Technical Support: 1-855-855-8926

Please Note:

- This Kuzco LED fixtures come with pre-wired LED module(s)
- Unless instructed, Do Not touch any part of the LED module(s) as any unnecessary contact with the module could cause permanent damage
- Use ELV (Electronic Low Voltage) or TRIAC type of dimmer for dimming application

- 1.** Remove fixture from its original package
- 2.** Separate mounting plate (**1c**) from canopy (**2a**) by removing canopy screws (**2f**)
- 3.** Attach mounting plate (**1c**) to electrical junction box (**1a**) using screws provided (**1e**) in hardware package
- 4.** Determine hanging height of fixture by securing rods (**2d**)
- 5.** Secure mounting plate (**1c**) to mounting surface with anchors (**1f**) and screws (**1h**)
- 6.** Make proper electrical connections (black to hot "L", white to neutral "N", ground to "GND") with wire nuts (**1b**) provided in hardware package
- 7.** Attach canopy (**2a**) to mounting plate (**1c**) with canopy screws (**2f**)

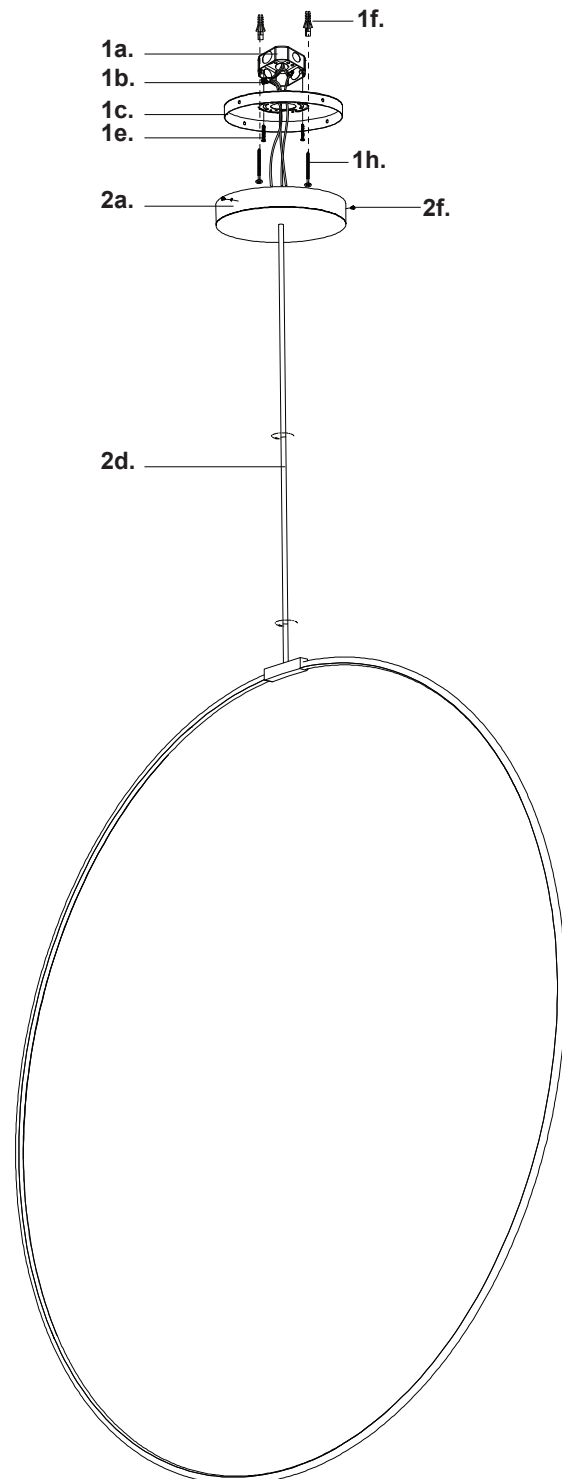

KUZCO

19054 28th Avenue Surrey, BC Canada V3Z 6M3
T: 604 538 7162 TF: 1-855 85 KUZCO F: 604 538 7196
W: kuzcolighting.com
20191113