

# Ceiling LED Pendant

# PD986172

INSTALLATION SHEET

## START FROM HERE

- Make sure **POWER** is **COMPLETELY OFF** at the fuse box
- Have your fixture installed by a qualified licensed electrician
- Prepare everything in a clear area
- Wear gloves at all time during this installation
- Read instructions carefully before you start assembly
- Keep this installation sheet for future reference

### Please Note:

- This Kuzco LED fixtures come with pre-wired LED module(s)
- Unless instructed, Do Not touch any part of the LED module(s) as any unnecessary contact with the module could cause permanent damage
- Use ELV (Electronic Low Voltage) or TRIAC type of dimmer for dimming application

Technical Support: 1-855-855-8926

1. Remove fixture from its original package
2. Separate mounting plate (1c) from canopy (2a) by removing canopy screws (2f)
3. Attach mounting plate (1c) to electrical junction box (1a) using screws provided (1e) in hardware package
4. Add plastic anchors (3a) to the ceiling and wood backing and secure aircraft cable barrels (3b) to it with screws (3c)
5. To change fixture height, push and hold wire gripper (2g), slide wire to desired length and then release wire gripper to secure (Remove excess wire if necessary)
6. Make proper electrical connections (black to hot "L", white to neutral "N", ground to "GND") with wire nuts (1b) provided in hardware package
7. Attach canopy (2a) to mounting plate (1c) with canopy screws (2f)

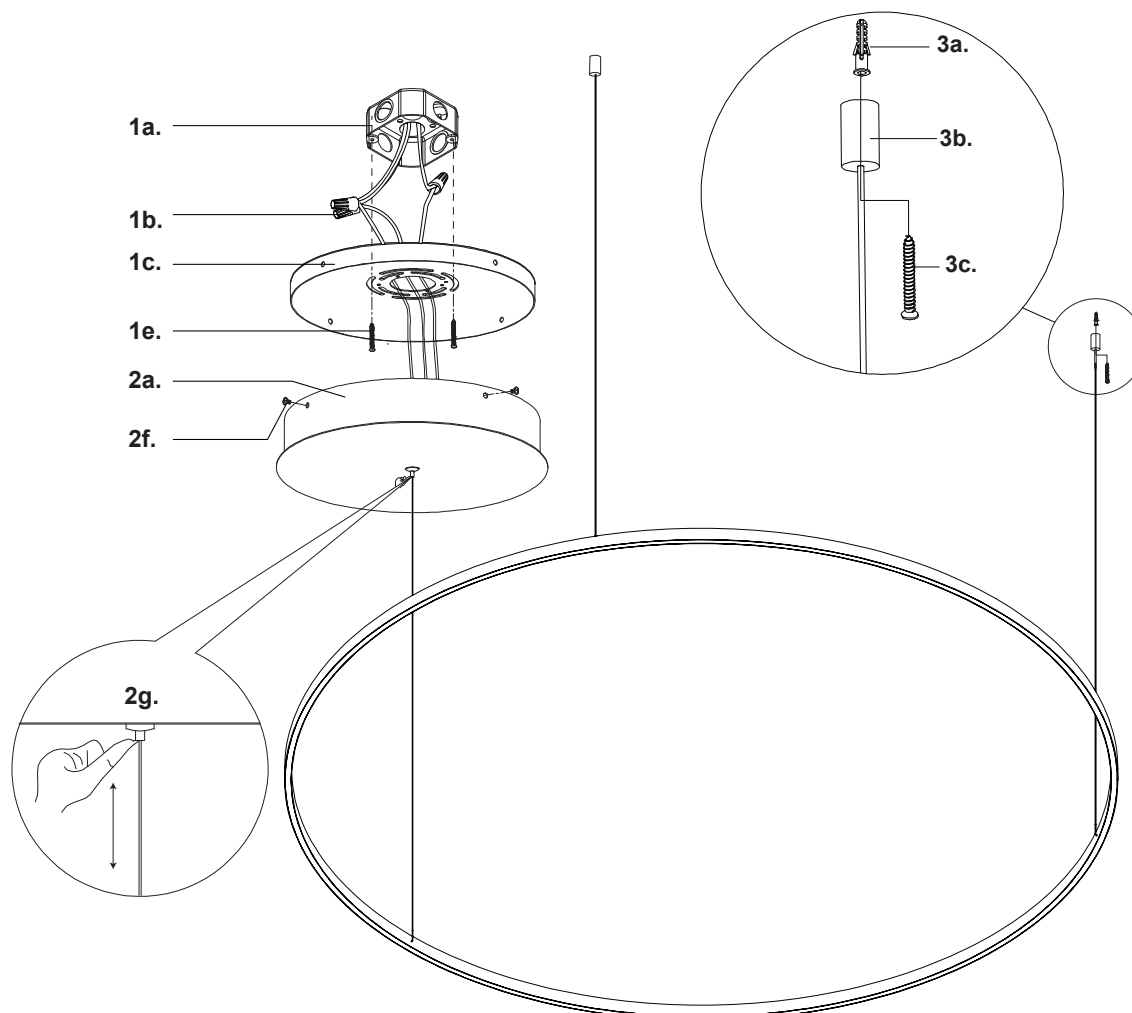

# KUZCO

19054 28th Avenue Surrey, BC Canada V3Z 6M3  
T: 604 538 7162 TF: 1-855 85 KUZCO F: 604 538 7196  
W: kuzcolighting.com  
20191108