

Single lamp vanity with white squared acrylic

VL6224-CH INSTALLATION SHEET

Please Note:

- All Kuzco LED fixtures come with pre-wired LED module(s).
- Unless instructed to do so, please do not touch any part of the LED module(s) as any unnecessary contact with the module could cause permanent damage.
- For dimming, an ELV (Electronic Low Voltage) dimmer is required.

START FROM HERE

- Make sure power is completely off at the fuse box.
- Have your fixture installed by a qualified licensed electrician
- Prepare everything in clear area.
- Wear gloves at all times during this installation.
- Read instructions carefully before you start assembly.
- Keep this instruction sheet for future reference.

Technical Support: 1-855-855-8926

1. Remove the fixture from its original packaging and remove the fixture mounting plate from within the hardware package. Attach the fixture mounting plate to the electrical junction box (1a) on the wall using the two screws provided in the hardware package.

2. Attach the fixture (2a) to the mounting plate (2b), which is attached to the electrical junction box on the wall. First attach all wiring with the provided marrets (2c) (white to white "N", black to black "L", ground to ground "G"). Secure the mounting plate (2b) to the junction box using the two threaded bolts. Connect the fixture (2a) to the mounting plate. Be sure to align the two support bolts to the fixture plate holes (2a). Once this is complete you can screw on the decorative nuts (2e) until the fixture (2a) is secured to the wall.

3. Install the acrylic cover (3a) onto the fixture. The acrylic cover is installed by gently pushing it forward between the two end plates. When the acrylic meets the fixture increase pressure until the acrylic catches the fixtures top and bottom leading edges by the bracket. Lastly, connect the decorative end plates (3b) to the fixture using the machine screws provided.

4. You have now completed the installation of your fixture, enjoy.

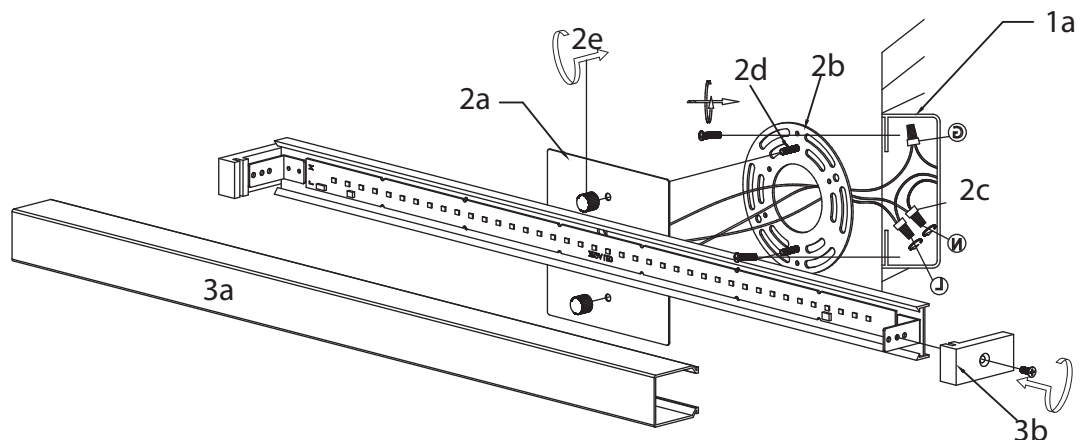

KUZCO

19054 28th Avenue Surrey, BC Canada V3Z 6M3
T: 604 538 7162 TF: 1-855 85 KUZCO F: 604 538 7196
W: kuzcolighting.com
20181127