

LED Lamp Wall Sconce

WS10502

INSTALLATION SHEET

Please Note:

- All Kuzco LED fixtures come with pre-wired LED module(s).
- Unless instructed to do so, please do not touch any part of the LED module(s) as any unnecessary contact with the module could cause permanent damage.
- For dimming, an ELV (Electronic Low Voltage) dimmer is required.

START FROM HERE

- Make sure power is completely off at the fuse box.
- Have your fixture installed by a qualified licensed electrician
- Prepare everything in clear area.
- Wear gloves at all times during this installation.
- Read instructions carefully before you start assembly.
- Keep this instruction sheet for future reference.

Technical Support: 1-855-855-8926

- 1.** Remove the fixture from its original packaging. Remove the mounting plate from within the canopy and attach it to the electrical junction box, and wall, using the two screws provided in the hardware package
- 2.** Attach the canopy to junction box on the wall. First attach all wiring (**2a**) with the provided marrets (white to white "N", black to black "L", ground to ground "G"). Thread the screws (**2b**) through the canopy plate and tighten into mounting plate. Lastly, place the fixture (**2C**) onto the canopy plate and secure with set screws (**2D**).
- 3.** You have now completed the installation of your fixture, please enjoy.

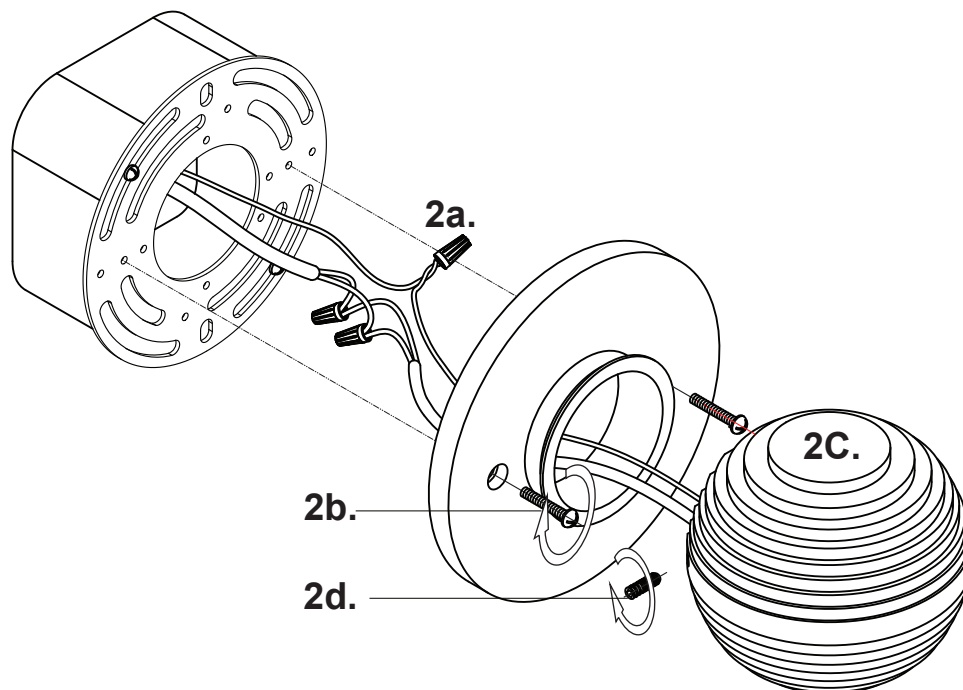

KUZCO

19054 28th Avenue Surrey, BC Canada V3Z 6M3
T: 604 538 7162 TF: 1-855 85 KUZCO F: 604 538 7196
W: kuzcolighting.com
20181127